

Schaltschema für SABA-Sabine L

Konstruktionsänderung vorbehalten!

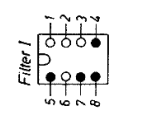
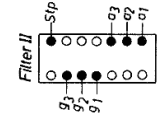
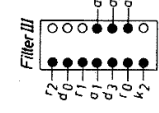
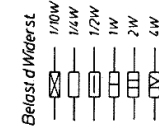
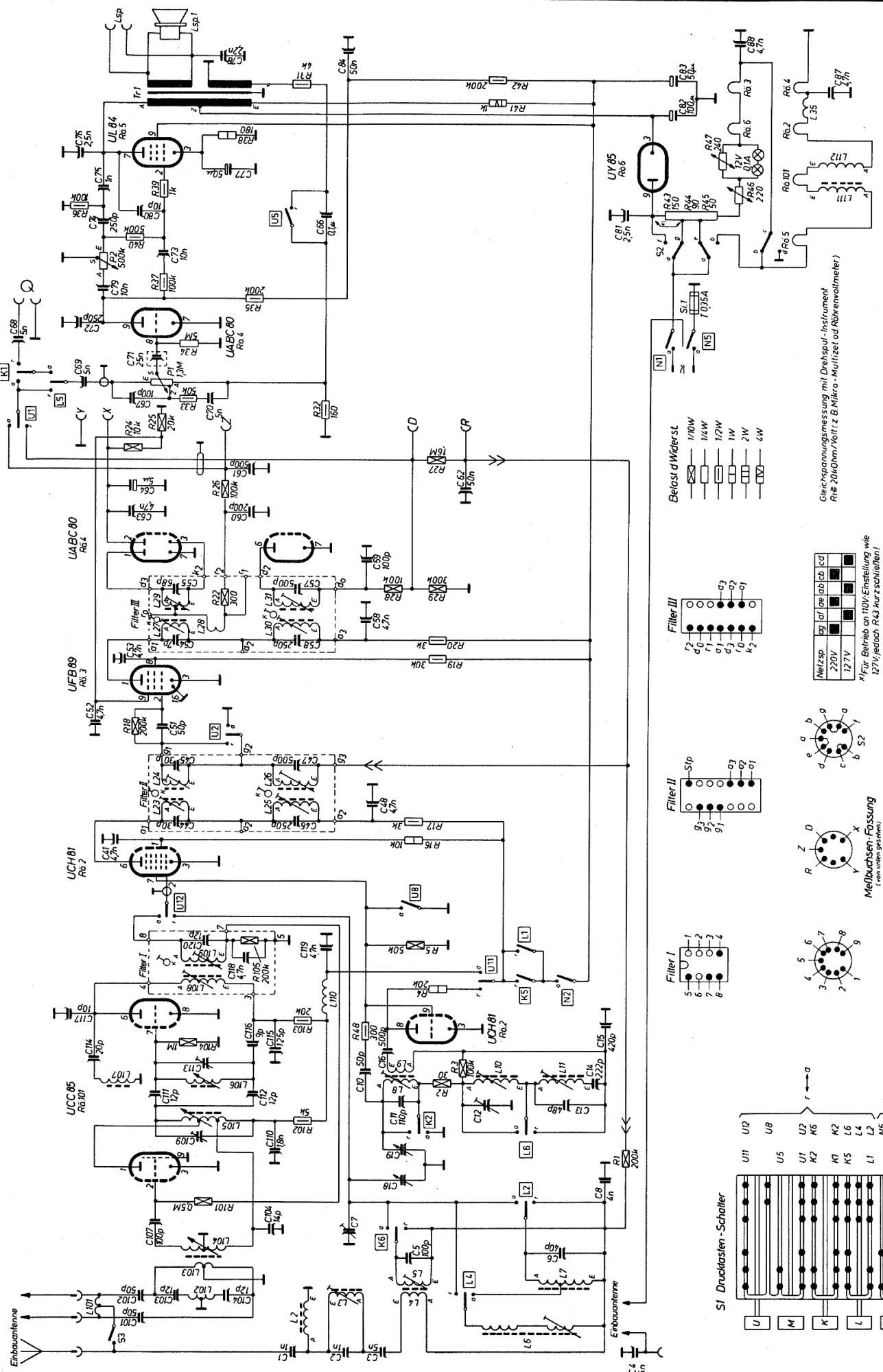

Netzsp	g1	af	ap	ab	ab	cd
220V	■	■	■	■	■	■
127V	■	■	■	■	■	■

* Für Betrieb an 110V-Einstellung wie 127V, jedoch R43 kurzschließen!

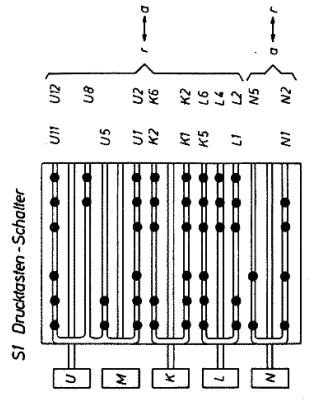
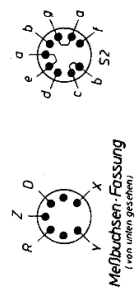

Gleichspannungsmessung mit Drehschl.-Instrument
 R1e 20kOhm Volt z.B. Mikro-Waritzler od. Röhrenvoltmeter)

Netzspannungswähler