

VACUUM TUBES OF SMALL DIMENSIONS FOR USE AT EXTREMELY HIGH FREQUENCIES*

BY

B. J. THOMPSON AND G. M. ROSE, JR.

Research and Engineering Department, RCA Manufacturing Company, Inc., Harrison, N. J.

Summary—This paper describes the construction and operation of very small triodes and screen-grid tubes intended for reception at wavelengths down to 60 centimeters with conventional circuits.

The tubes represent nearly a tenfold reduction in dimensions as compared with conventional receiving tubes, but compare favorably with them in transconductance and amplification factor. The interelectrode capacitances are only a fraction of those obtained in the larger tubes.

The triodes have been operated in a conventional feed-back oscillator circuit at a wavelength of 30 centimeters with a plate voltage of 115 volts and a plate current of 3 milliamperes.

Receivers have been constructed using the screen-grid tubes which afford tuned radio-frequency amplification at 100 centimeters and 75 centimeters, a gain of approximately four per stage being obtained at the longer wavelength.

INTRODUCTION

IN RECENT years interest in the possibilities of radio communication at wavelengths of less than three meters has been greatly increased, because of the imminent saturation of the spectrum of greater wavelengths and of the peculiar properties expected of these short waves. As a study of radio transmission requires transmitting and receiving apparatus, much effort has been devoted to the development of equipment suitable for such wavelengths, the types of tubes and circuits used at longer wavelengths having proved unsatisfactory. It is the purpose of this paper to describe a study of the possibilities of vacuum tubes of very small physical dimensions for use in radio reception at wavelengths as short as 60 centimeters.

As the minimum wavelength of commercial radio communication has been reduced, refinements of the previously existing types of receiving apparatus have been made, until it is now possible to use either tuned radio-frequency amplification or superheterodyne amplification followed by a triode type detector at wavelengths as short as five meters. It had been found that the vacuum tubes constituted the limit-

* Decimal classification: R331. Presented before I.R.E. Eighth Annual Convention, Chicago, Illinois, June 26, 1933. Presented before New York Meeting, October 4, 1933.

Reprinted from *Proc. I.R.E.*, December, 1933.

ing factors at about ten meters, and subsequent reduction in wavelength has been made possible by improvements in tube design. In all of this work the apparatus in use differs from the conventional long-wave apparatus only in refinement. The limit of the improvements by this method seems definitely to have been reached at about three to five meters wavelength, due to various characteristics of the tubes.

As what appeared to be a wall was reached in this refinement of conventional long-wave apparatus, it was natural that investigators should seek other and radically different means for reception. By far the greatest amount of attention has been devoted to the study of Barkhausen-Kurz¹ or Gill-Morrell² oscillations, which may readily be obtained at wavelengths as short as thirty centimeters. Many schemes for the use of these oscillations in reception have been described, some of the circuits resembling the well-known superregenerative detector, others being used as heterodyne detectors, but the majority being more obscure in their principles of operation.³ In general, all use only one tube—or one stage—at the ultra-high frequency, the amplification being carried out at an intermediate or low frequency. Other schemes have been proposed, using oscillating magnetrons, for example.

It is the authors' experience that these methods all suffer from one or more serious faults when considered from the standpoint of practical use. Nearly all of the methods are wasteful of plate power. Many are insensitive in the extreme. The more sensitive are unstable, in general. Tuning is broad. The most serious faults shared by all are limitation of sensitivity, due to the fact that no amplification may be had ahead of the detector, and radiation from the oscillator which is coupled directly to the antenna.

The purpose of the work described in this paper was to reduce the lower wavelength limit of the conventional types of tubes and circuits in order to obtain their advantages of simplicity at wavelengths below one meter.

THEORETICAL CONSIDERATIONS

The limitations imposed on tuned radio-frequency reception at the present lower wavelength limit are due to a number of factors. These are:

¹ H. Barkhausen and K. Kurz, *Phys. Zeit.*, vol. 21, no. 1; January, (1920).

² E. W. B. Gill and J. H. Morrell, *Phil. Mag.*, vol. 44, no. 161; July, (1922).

³ A considerable bibliography on this subject is given by W. H. Westrom, *Proc. I.R.E.*, vol. 20, no. 1, pp. 95-112; January, (1932). The papers by Hollmann, Uda, Okabe, and Beauvais, in particular, discuss receiving circuits.

(1) The interelectrode capacitances of the tube are so great that, with the addition of the tuning capacitance, the L/C ratio is too low for a value of impedance sufficient to afford appreciable amplification.

(2) The lead inductances of the tube are so great that much of the output voltage of the tube appears inside the bulb, where it is unavailable.

(3) The interelectrode capacitances and lead inductances form a tuned circuit at a wavelength well above the limit desired.

(4) The time of transit of the electrons across the space between electrodes becomes an appreciable part of a period which results in a reduction in the effective amplification of the tube.

(5) As the wavelength is reduced the radio-frequency resistance of the circuit is increased with a consequent reduction in resonant impedance.

It will be seen that most of these limitations are associated with too large a ratio of some fixed characteristic of the tube to those characteristics of the circuit which vary with frequency. These characteristics of the tube are fixed only for a given design; however, any change in design which results in lower transconductance, as would be the case with increased interelectrode spacing to reduce capacitance, cannot be considered a genuine improvement.

In a vacuum tube, if all linear physical dimensions are kept in a fixed ratio to each other there will be no change in transconductance, plate current, or amplification factor at fixed operating voltages, no matter what changes are made in the actual magnitude of the linear dimensions. On the other hand, the values of interelectrode capacitance, lead inductance, and time of electron transit are in direct proportion to the magnitude of the linear dimensions.⁴

These considerations lead directly to the principle on which this work is based: for optimum design at any wavelength, all tube and circuit linear dimensions should be in proportion to the wavelength. This principle is modified in practice since, at longer wavelengths, there is no advantage in making the tube of large size and it becomes inconvenient to make the tuned circuit of optimum dimensions.

Unfortunately, it is not to be expected that this proportionality of dimension will result in constant amplification, since the resonant impedance, L/RC , is reduced as the wavelength becomes shorter. However, on the basis of Butterworth's formulas for high-frequency resis-

⁴ A statement and proof of part of this may be found in that remarkable paper by Langmuir and Compton, "Electrical Discharges in Gases," Part II, *Rev. Mod. Phys.*, vol. 3, no. 2, p. 252; April, (1931).

tance⁵ and Coffin's formula for inductance, with Rosa's correction,⁶ a coil having the following dimensions:

$$\begin{aligned} \text{length} &= 1/8 \text{ in.} \\ \text{diameter} &= 1/8 \text{ in.} \\ \text{turns} &= 5 \\ \text{wire diameter} &= 0.020 \text{ in.} \end{aligned}$$

should have a resistance of 0.37 ohm and an inductance of 5.87×10^{-8} henry at 50 centimeters wavelength. A capacitance of 1.2×10^{-12} farad would be required for resonance, giving an impedance, L/RC of 132,000 ohms. This high value in comparison to those obtained at longer wavelengths may be accounted for in part by the fact that the

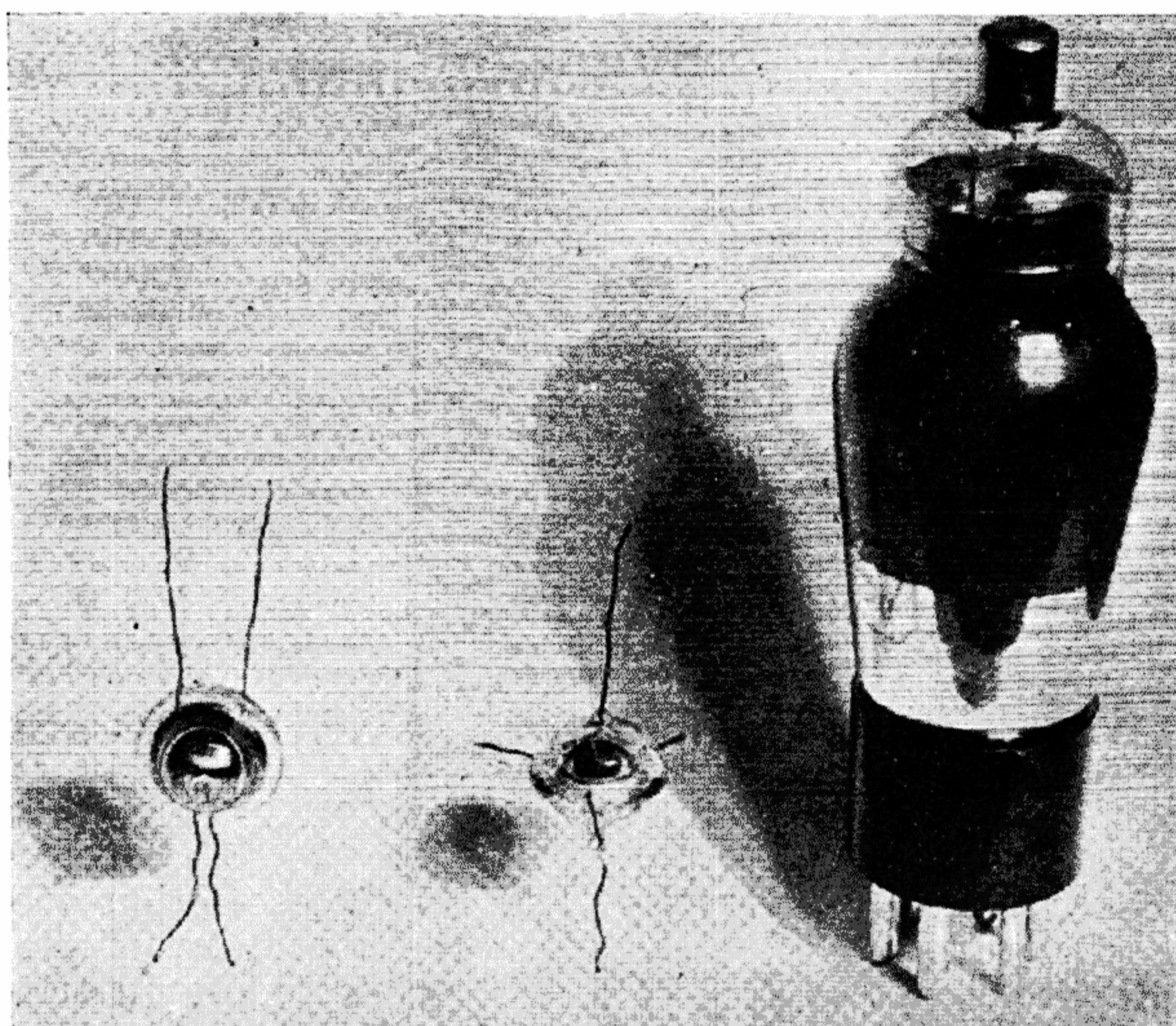

Fig. 1—Small triode and screen-grid tube compared with a conventional size 57 type tube. The triode is shown at the left.

coil is of much more nearly optimum design than those used at the longer wavelengths.

Since tubes of conventional size have been found to have a lower wavelength limit of about five meters, the principle of proportionality requires a tenfold reduction of linear dimension to produce a tube capable of amplification at a wavelength of 50 centimeters.

Both screen-grid tubes and triodes representing such reductions have been constructed and studied in operation.

⁵ S. Butterworth, *Exp. W. & W. Eng.*, vol. 3, nos. 31, 32, and 34, pp. 203-210; 309-316; 417-424; April, May, and July, (1926).

⁶ E. B. Rosa and F. W. Grover, Scientific Paper of the Bureau of Standards No. 169, third edition, pp. 117-122, December, (1916).

TUBE STRUCTURE

A photograph of these tubes is shown in Figure 1. A conventional size type 57 tube serves as a standard of comparison. The largest dimension of either of these small tubes is less than three quarters of an inch, and the elements themselves are correspondingly small.

Both types of tubes are of parallel plane construction and have indirectly heated cathodes.

In the triode the parts are sufficiently light in weight to permit supporting them on their lead wires alone. This has resulted in the elimination of capacitances which would otherwise be present between the various elements and the support structure. Both plate and cathode

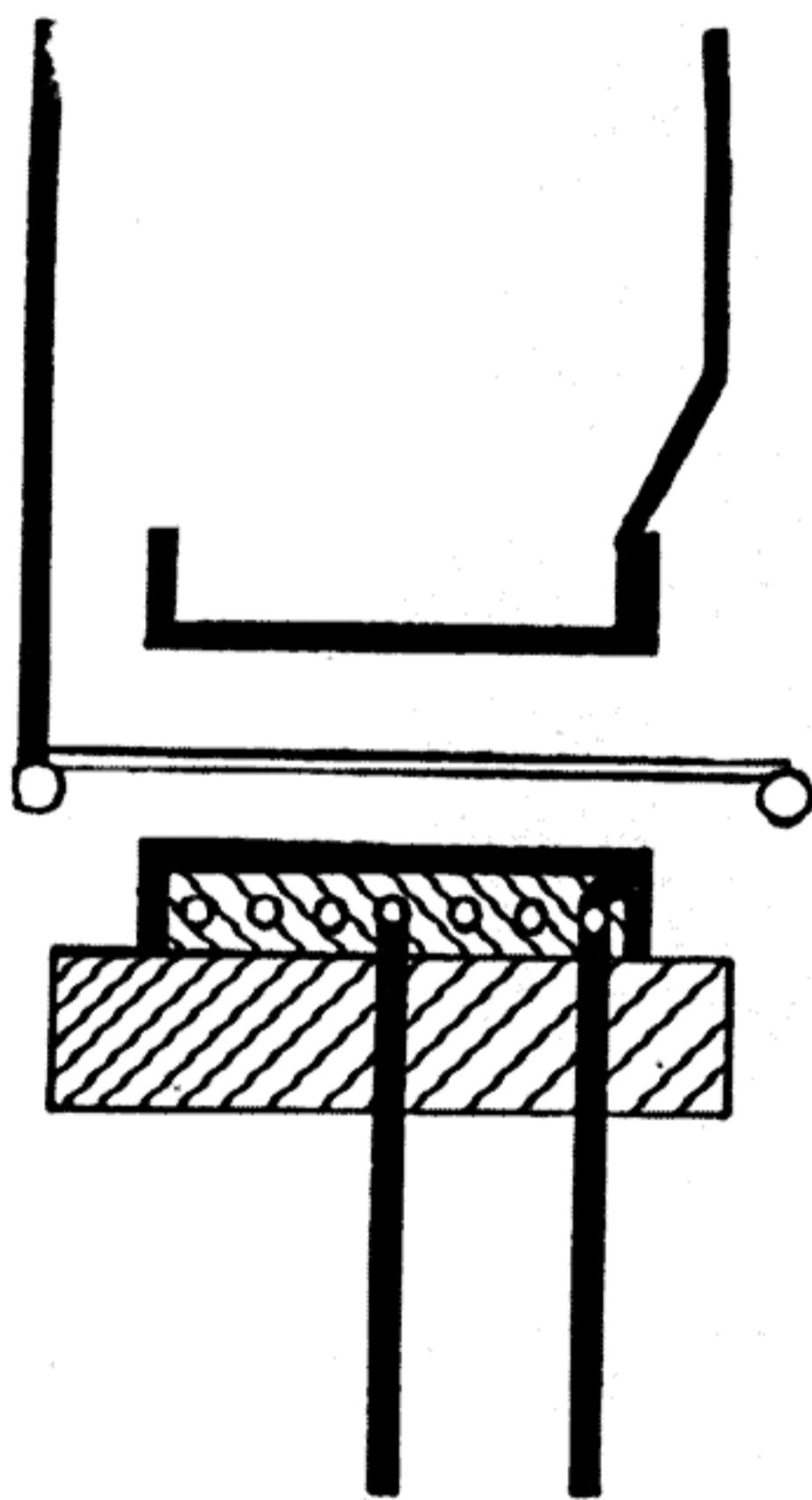

Fig. 2—Cross-section view showing the structure of the small triode.

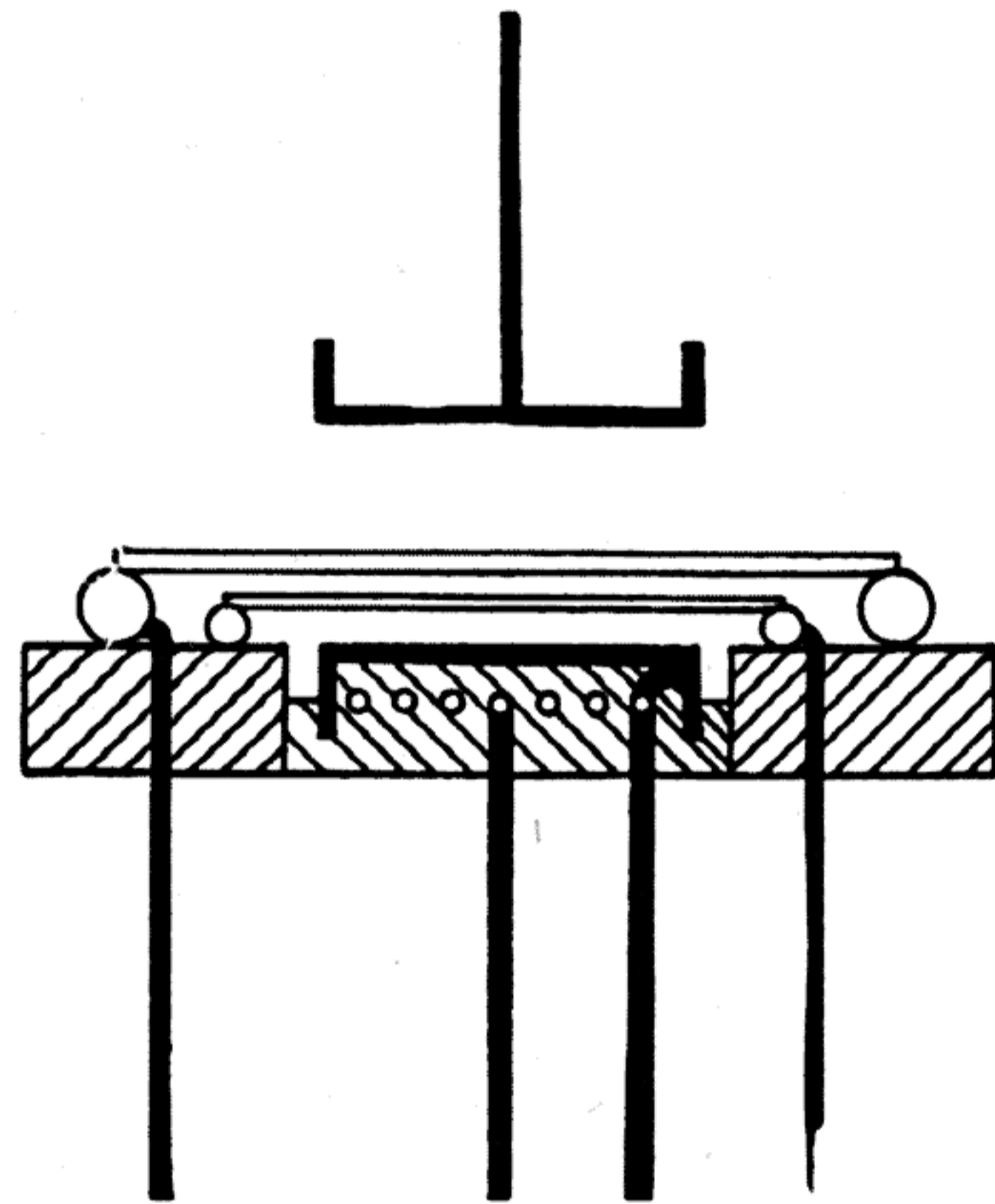

Fig. 3—Cross-section view showing the structure of the small screen-grid tube.

are of the same shape, consisting of two small metal cups placed back to back with the grid interposed between them. The cathode cup has within it a small heater; its outer surface is coated with the emitting material. The grid is of mesh fastened on a support ring. The inter-electrode spacings are only a few thousandths of an inch. Figure 2 shows the general construction.

The assembly scheme of the triode cannot be satisfactorily applied to the screen-grid tube because of mechanical complications arising from the presence of the second grid. A different method is used which is productive of a stronger and more rigid assembly. The tetrode parts, however, are of the same size and shape as those of the triode, with the addition of the screen grid which is similar to the control grid though somewhat larger.

A small ceramic disk serves as a foundation upon which the tube parts, with the exception of the plate, are assembled. It, therefore, acts as a common supporting insulator. The correct spacings between the grids and the cathode are obtained by adjusting their individual distances from this insulator. As the distance from the plate to the screen grid is not so critical, the plate is supported by its lead wire from the glass bulb. The spacings between the other parts is again only a few thousandths of an inch. The general construction is shown in Figure 3.

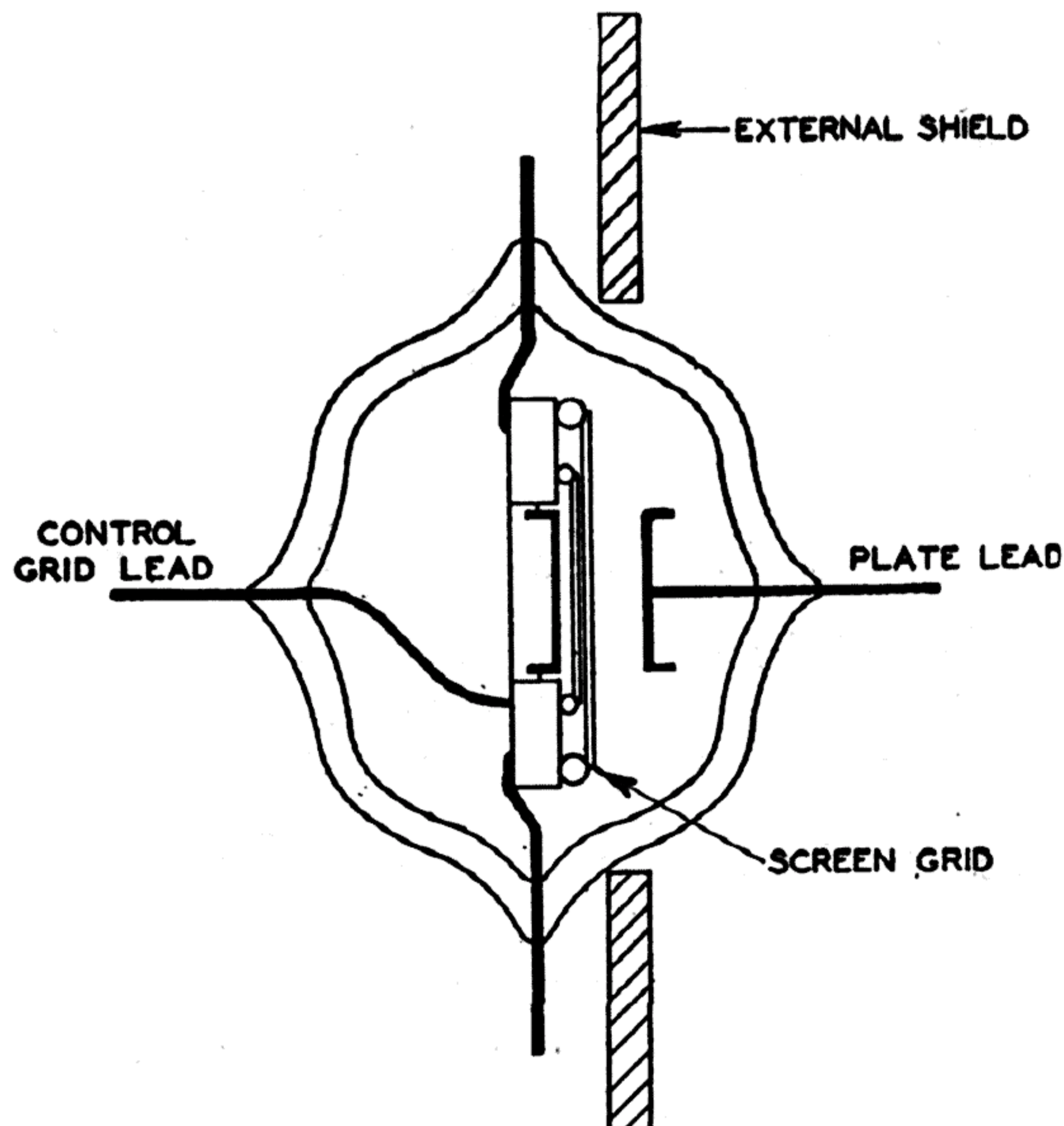

Fig. 4—View showing the screening arrangement used with the small screen-grid tube.

The bulbs used to enclose both types of tubes are in two parts which are more or less hemispherical in shape. These two parts are placed together with the mount inside, and a seal is made between them. All of the triode leads pass through this seal, thereby eliminating the need for a stem as ordinarily used. In the tetrode separate seals are made at opposite ends of the bulb for the plate and control-grid leads while all of the remaining leads come out through the main seal.

In the case of the tetrode this general arrangement has advantages from the standpoint of screening. The mount is so placed in the bulb that its screen grid lies just above the plane of the seal and extends almost to the glass. It is readily seen from Figure 4 that when the external shield is placed as indicated the plate is effectively isolated

from the control grid. The screen-grid lead is quite short and comes out adjacent to the external shield where it can be readily grounded,

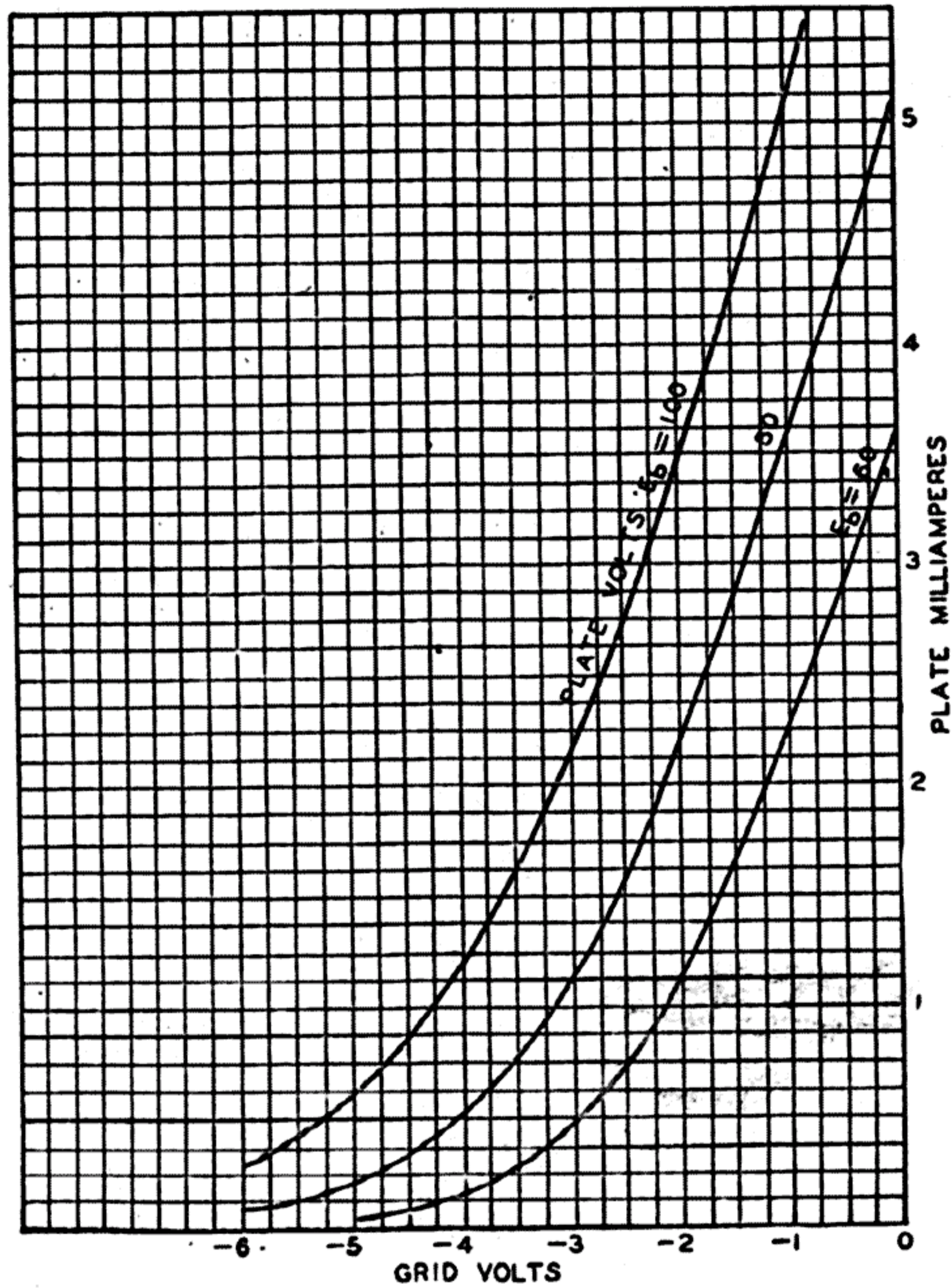

Fig. 5—Mutual characteristics of the small triode.

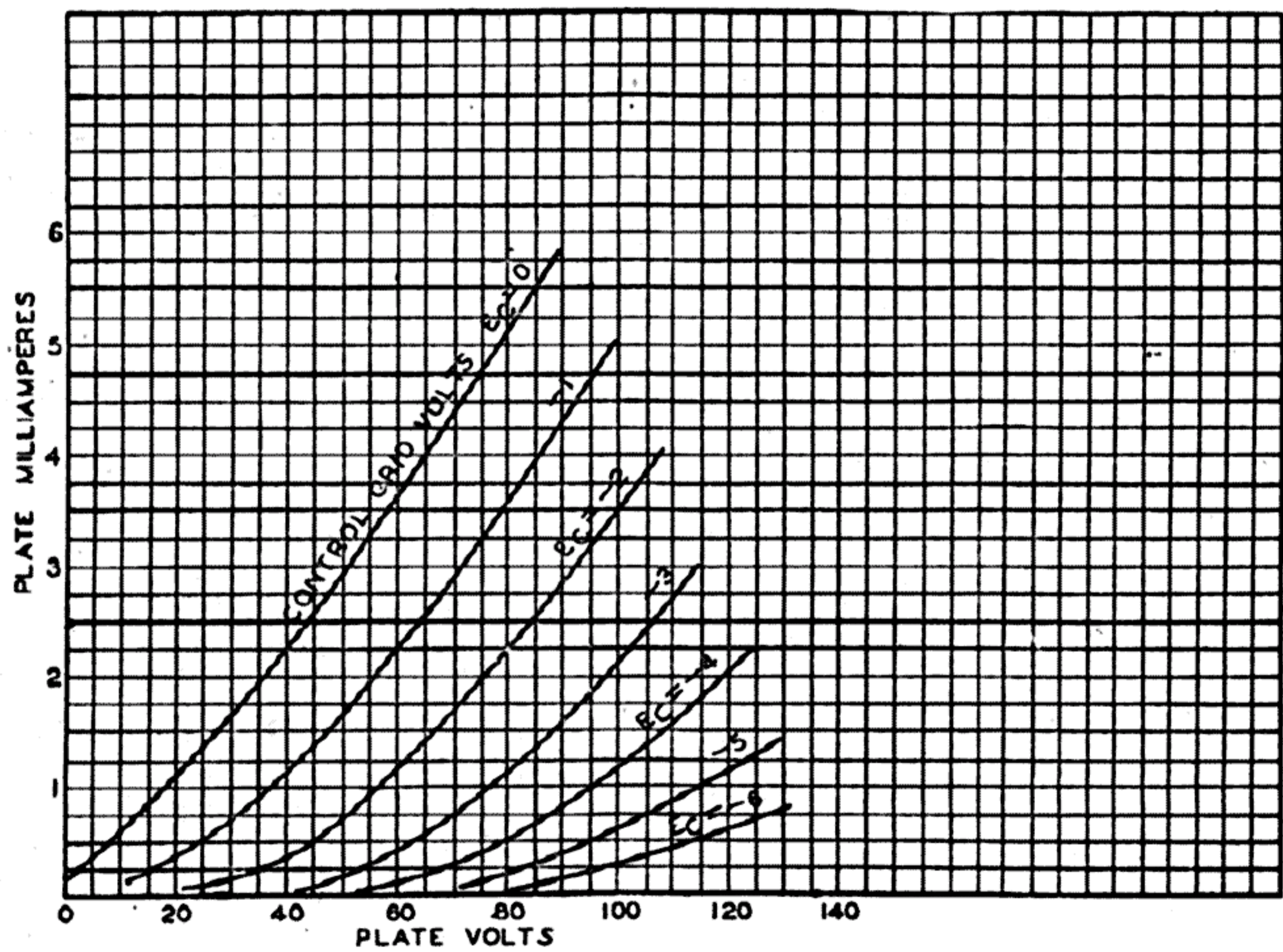

Fig. 6—Plate characteristics of the small triode.

thus minimizing screen-lead impedance. This holds true for the heater and cathode leads likewise.

ELECTRICAL CHARACTERISTICS

From an examination of the static characteristics of the triode, which are shown in Figures 5 and 6, it is readily seen that these characteristics are directly comparable both as to magnitude and shape with those of an ordinary triode. Under the operating conditions, plate voltage = 67.5 volts and grid voltage = -2 volts, the values of the various parameters are as follows:

$$\begin{aligned} \text{Plate current} &= 4 \text{ ma} \\ \text{Plate resistance} &= 9,500 \text{ ohms} \\ \text{Transconductance} &= 1550 \mu\text{a/v} \\ \text{Amplification factor} &= 14.7. \end{aligned}$$

The interelectrode capacitances for these tubes have been measured as follows:

$$\begin{aligned} \text{Grid-cathode capacitance} &= 0.7 \mu\mu\text{f} \\ \text{Plate-cathode capacitance} &= 0.07 \mu\mu\text{f} \\ \text{Plate-grid capacitance} &= 0.8 \mu\mu\text{f}. \end{aligned}$$

As might be predicted from the results of the measurements on the triode, the tetrode characteristics are likewise similar to those of the larger tubes of this sort. A family of plate-current—plate-voltage curves is shown in Figure 7. Points were not taken for the lower values of plate voltage because of the excessive values of screen-grid current. The mutual family of curves is given in Figure 8. Under the operating conditions, control-grid voltage = -0.5 volt, screen-grid voltage = 67.5 volts, and plate voltage = 135 volts,

$$\begin{aligned} \text{Plate current} &= 4.0 \text{ ma} \\ \text{Transconductance} &= 1100 \mu\text{a/v} \\ \text{Plate resistance} &= 360,000 \text{ ohms} \\ \text{Amplification factor} &= 400. \end{aligned}$$

The values of the interelectrode capacitances are:

$$\begin{aligned} \text{Input capacitance} &= 2.5 \mu\mu\text{f} \\ \text{Output capacitance} &= 0.5 \mu\mu\text{f} \\ \text{Plate-grid capacitance} &= 0.015 \mu\mu\text{f}. \end{aligned}$$

OPERATION

Tests have been made upon both the triodes and the screen-grid tubes to determine how well they will perform in conventional circuits at wavelengths much lower than the minimum at which ordinary tubes will function.

The minimum wavelength at which a triode will generate oscillations offers a means for comparing it with ordinary tubes. The value

of this minimum wavelength of oscillation is of particular interest here because it shows how closely a normal feed-back oscillator can

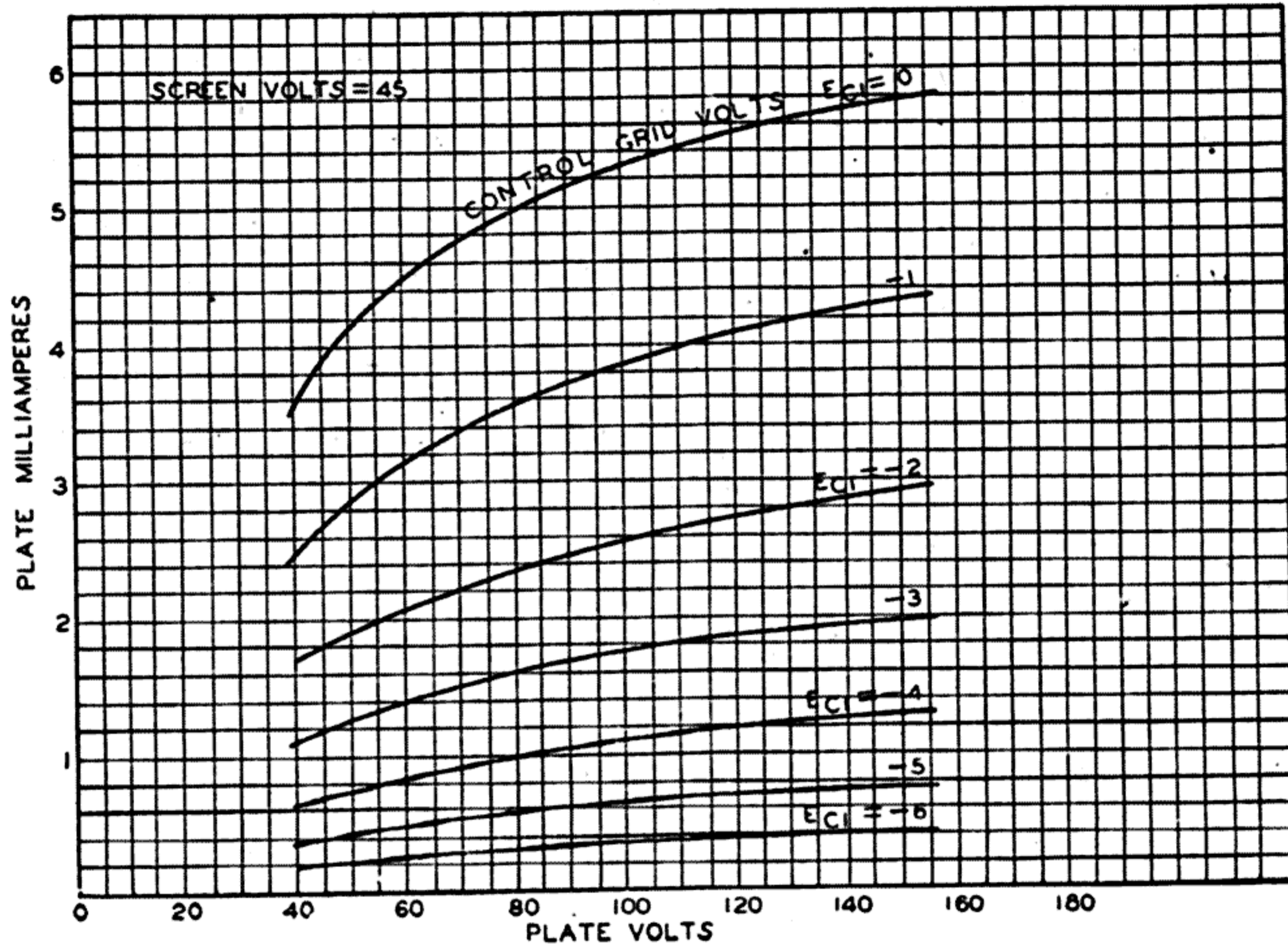

Fig. 7—Plate characteristics of the small screen-grid tube.

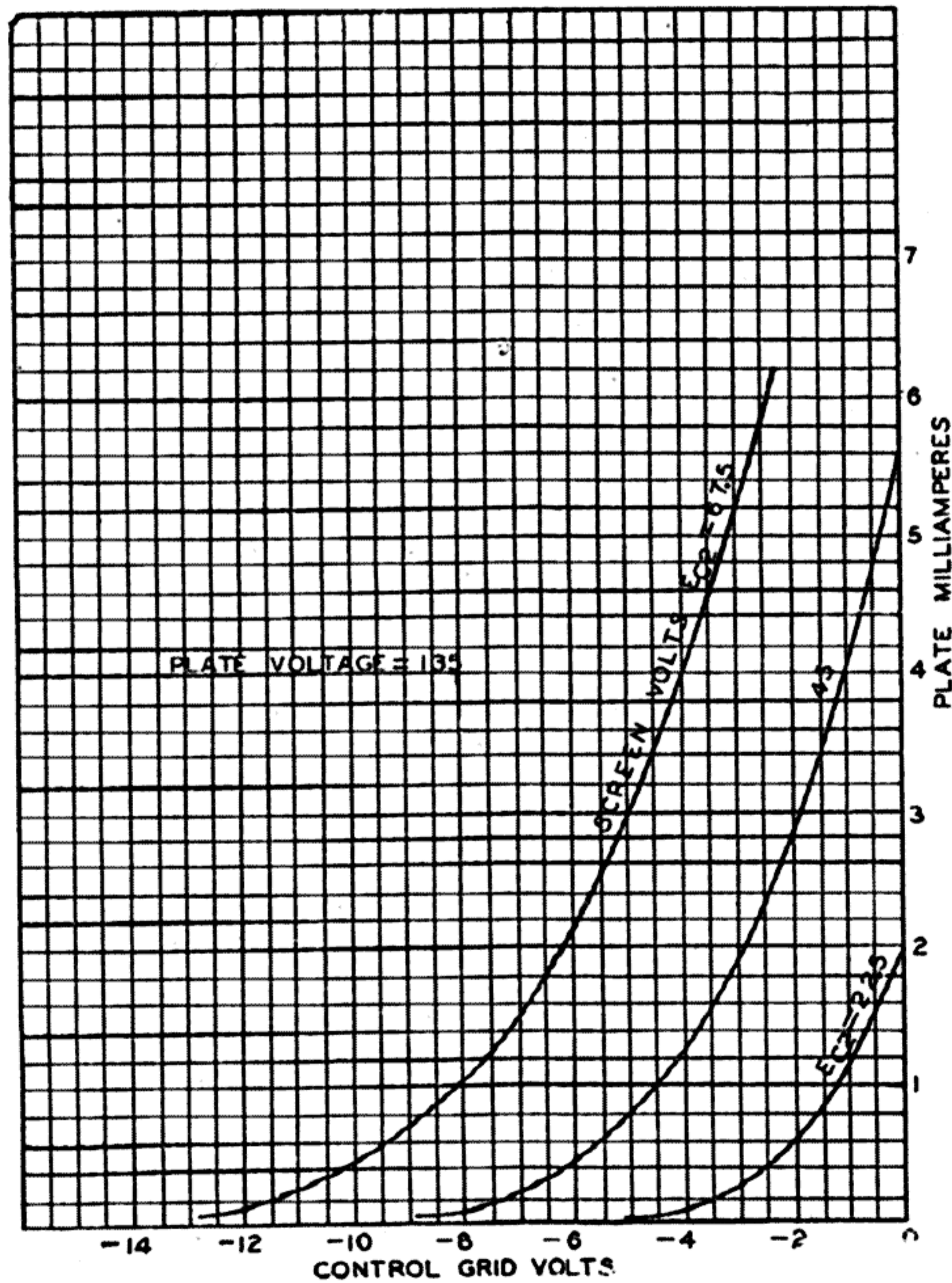

Fig. 8—Mutual characteristics of the small screen-grid tube.

approach those wavelengths generated almost solely by Barkhausen tubes and circuits.

An inductive feed-back oscillator was set up whose inductance consisted of several turns of small copper wire wound in a solenoid about

one-eighth of an inch in diameter tuned only by the tube interelectrode capacitances. The circuit is given in Figure 9, while a photograph of

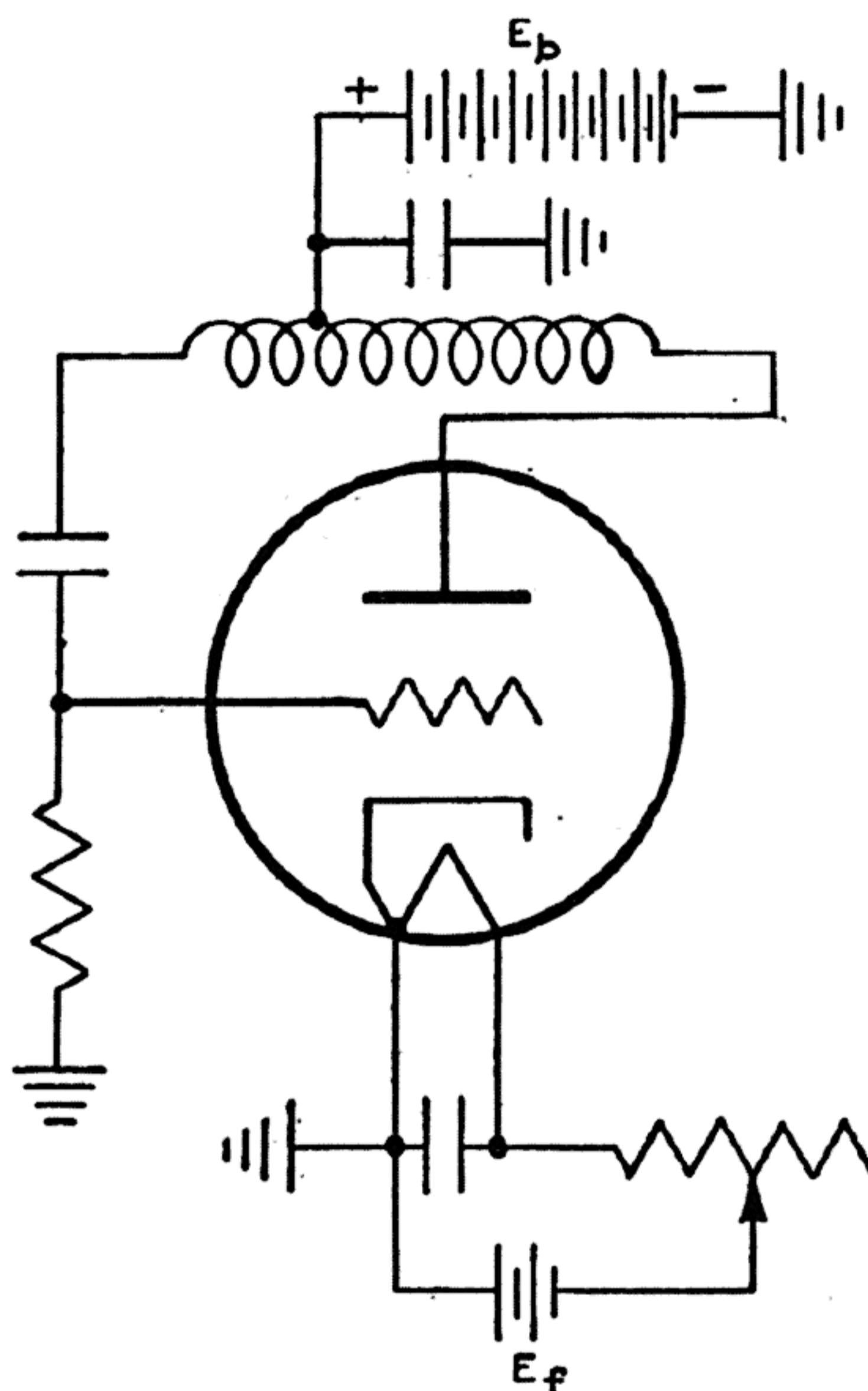

Fig. 9—Circuit diagram of the ultra-high-frequency oscillator using the small triode.

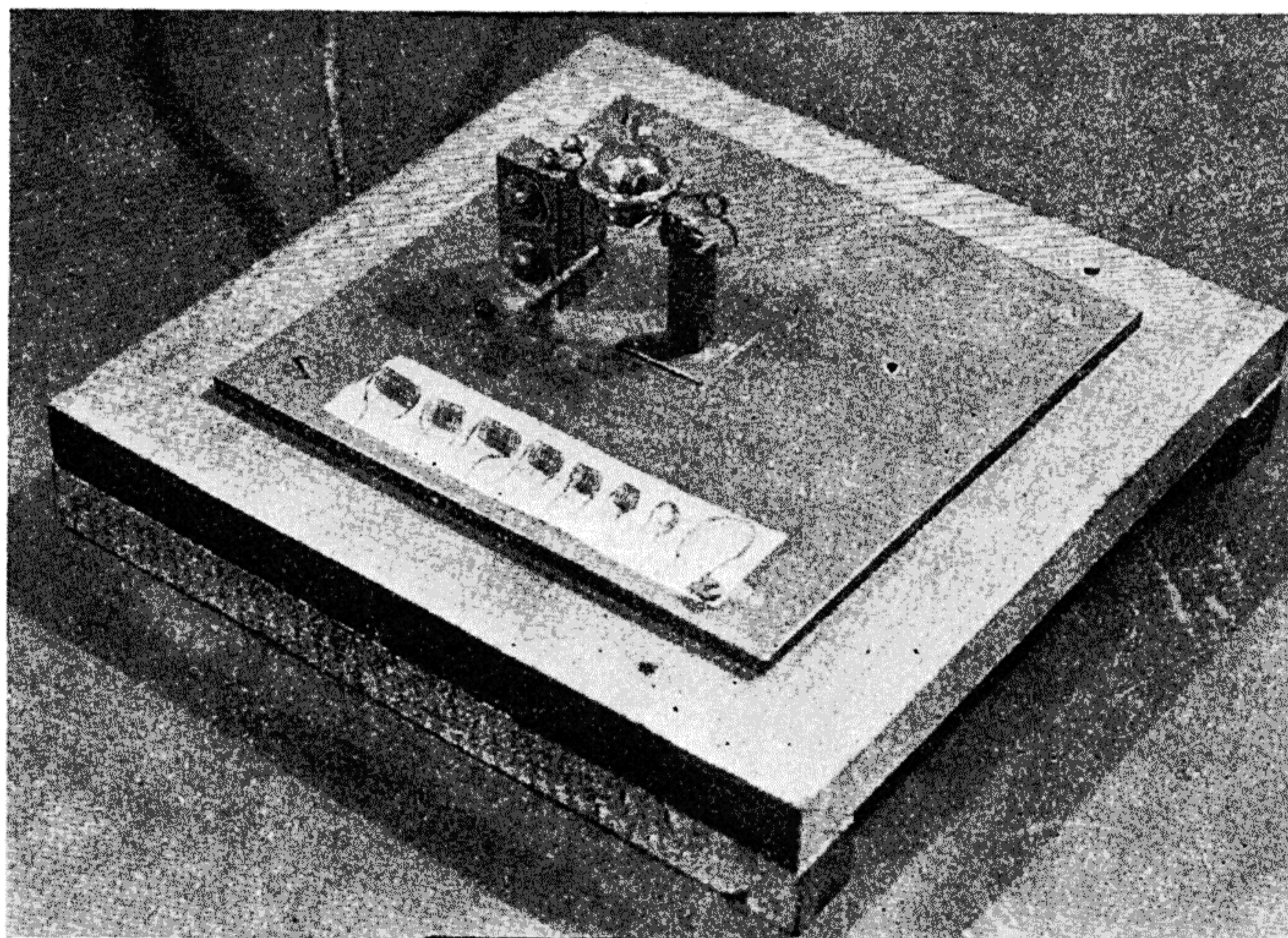

Fig. 10—Photograph of the ultra-high-frequency oscillator. Several tuning coils for different wavelengths are shown.

the oscillator is shown in Figure 10. With a coil of six turns very stable 65-centimeter oscillations were produced with as low as 45 volts on the plate of the tube. Smaller coils gave shorter wavelengths with

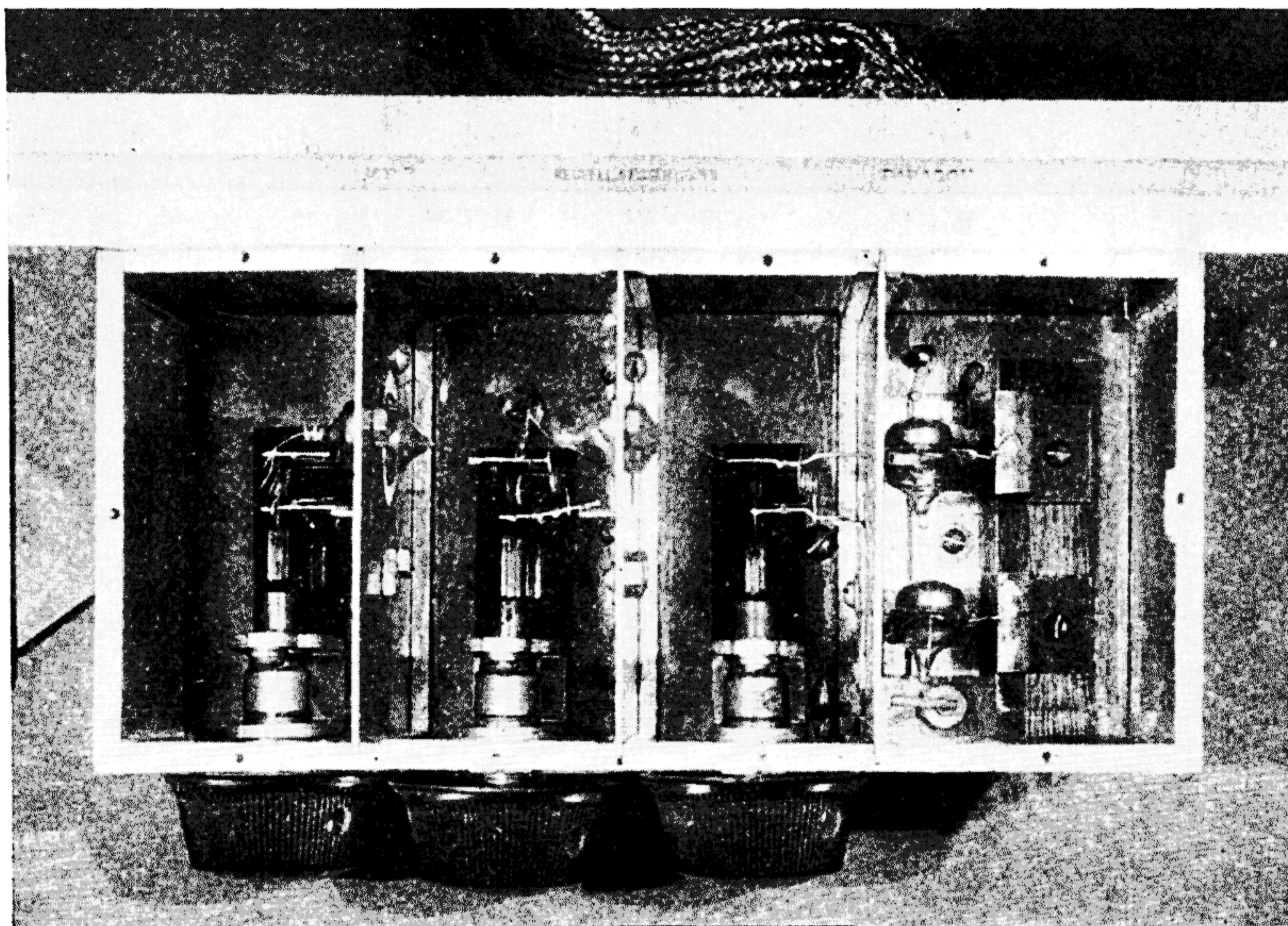

Fig. 11—Photograph of a tuned radio-frequency receiver for a wavelength of 100 centimeters.

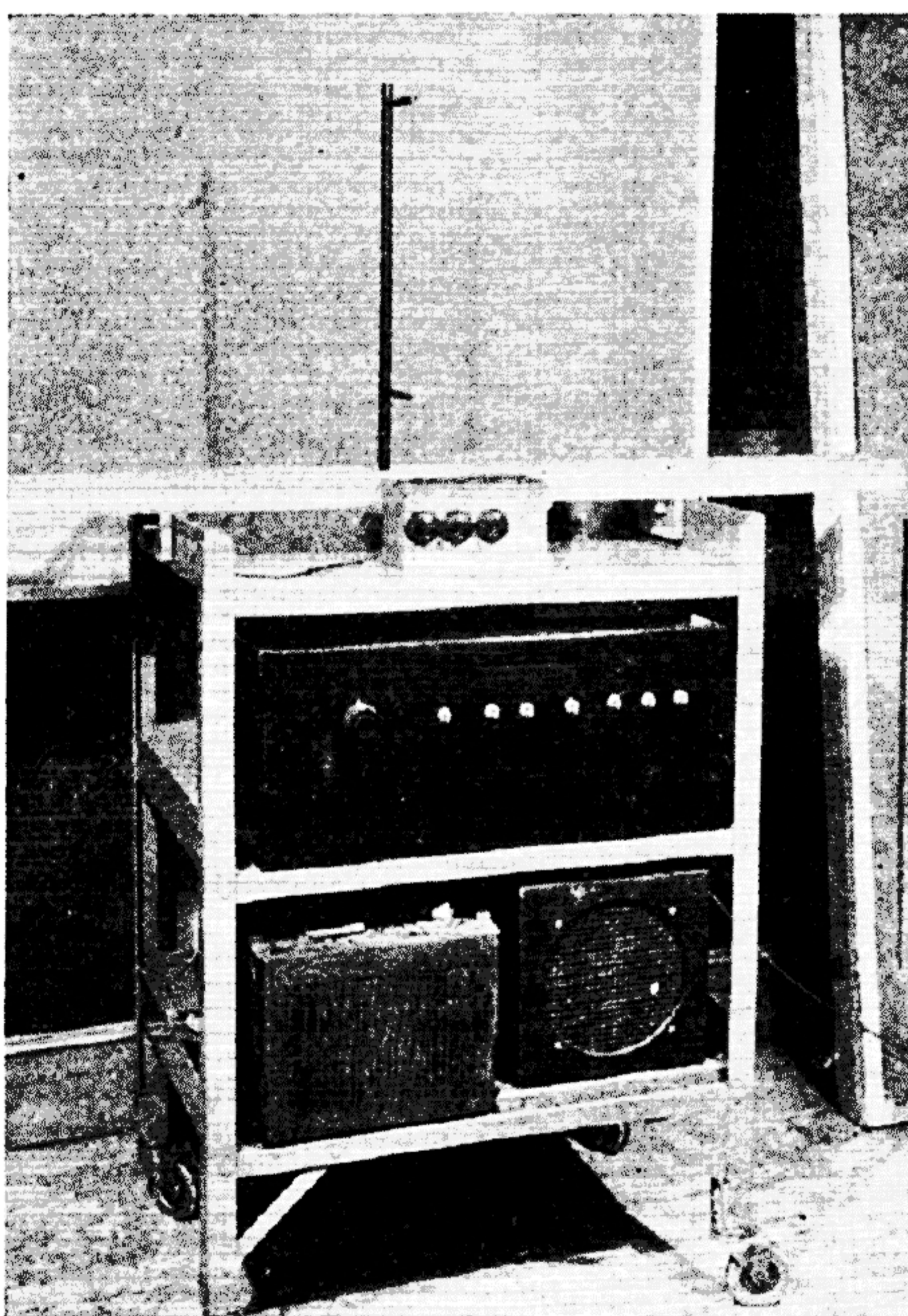

Fig. 12—Photograph of the complete 100-centimeter receiver arrangement.

continued stability until a minimum wavelength of slightly below 30 centimeters was reached with a coil of only one turn. Oscillations at this wavelength could be sustained with as low as 115 volts on the plate of the tube and with a plate current of approximately 3 milliamperes.

Owing to the difficulty of making quantitative measurements of radio-frequency amplification at wavelengths of one meter and less, the gain realizable by the use of the screen-grid tubes was determined by their operation in actual receiving sets. The first set consisted of two stages of tuned radio-frequency amplification, a detector, and one stage of audio-frequency amplification. The screen-grid tubes were

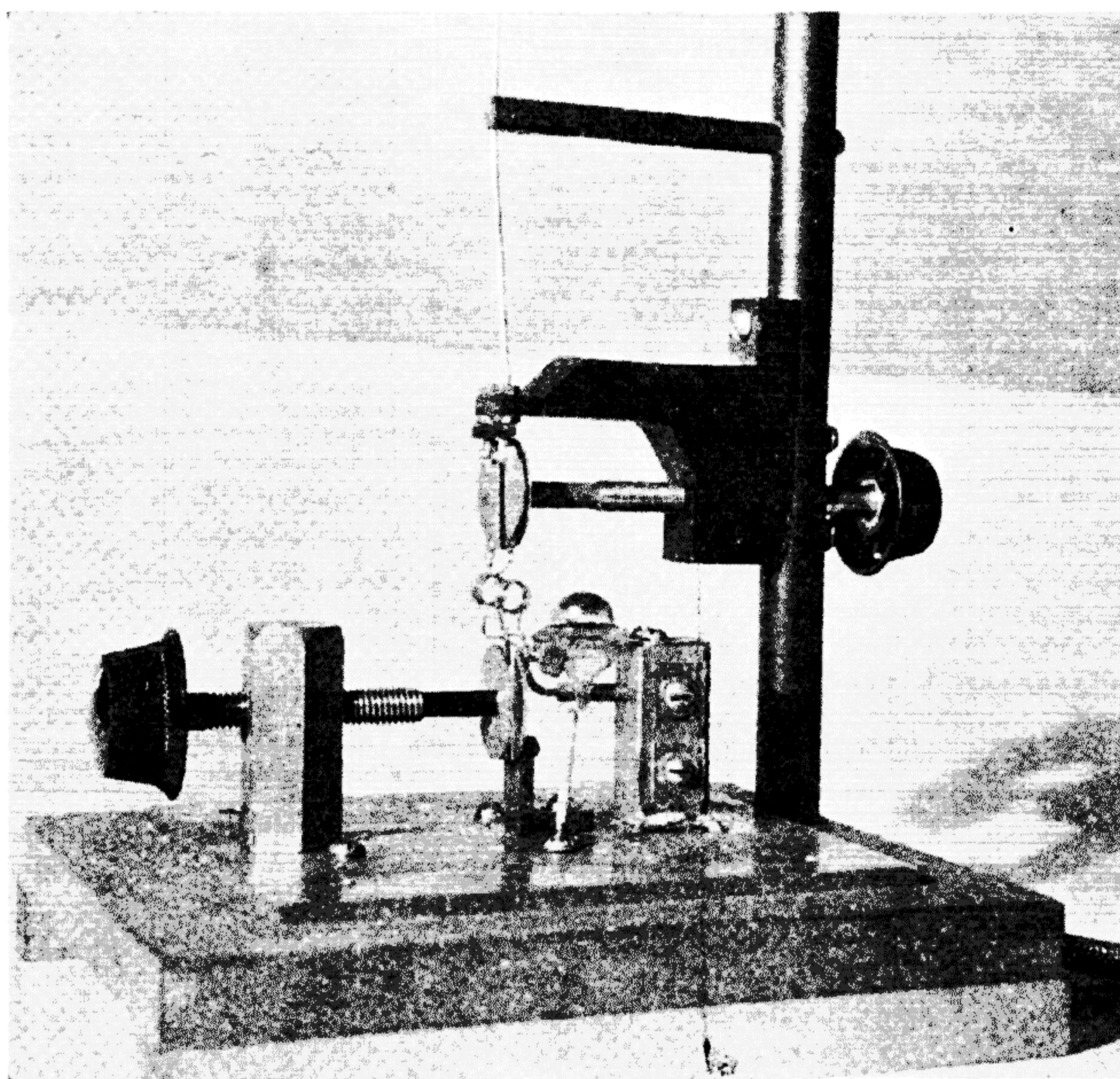

Fig. 13—Photograph of the 100-centimeter oscillator.

used in the radio-frequency amplifier stages and the small triodes as the detector and audio amplifier. The whole set, of which photographs are shown in Figures 11 and 12, was enclosed in a brass box seven inches long, three inches high, and three inches wide. Small coils such as those used in the oscillator tuned by almost equally small variable condensers constituted the tuned circuits. In order to prevent any signal pick-up except through the antenna, the batteries and all external leads were enclosed in metal shielding. With the set so shielded there was no trace of oscillation in any of the circuits. The tuning range of the receiver was from about 95 to about 110 centimeters.

An oscillator operating at a wavelength of 100 centimeters, consisting of one of the small triodes modulated by a broadcast receiver and loosely coupled to a half-wave radiator, was set up in an open area. The total plate power supplied to the oscillator was 68 milliwatts. Photographs of this transmitter are shown in Figures 13 and 14.

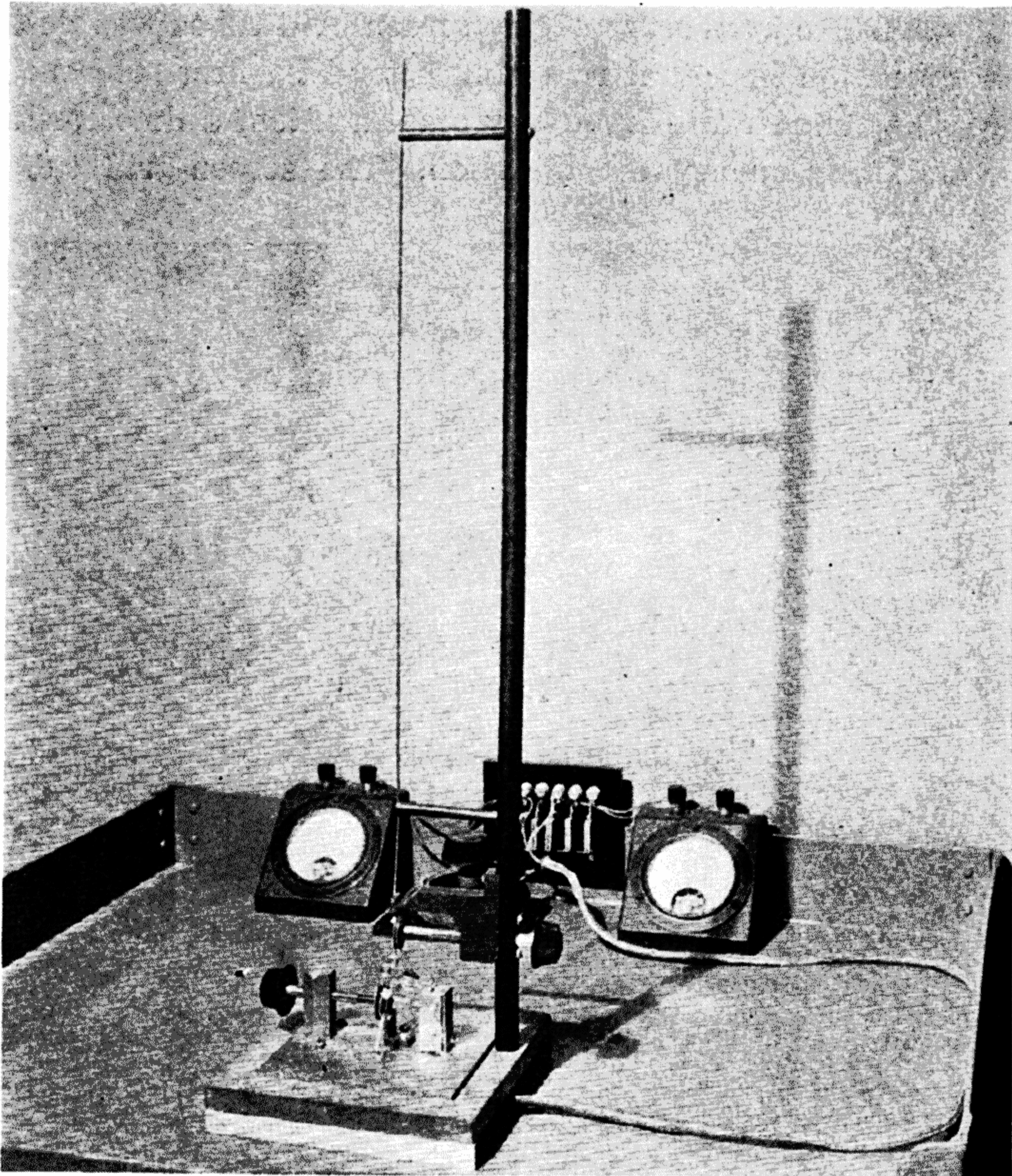

Fig. 14—Photograph of the 100-centimeter transmitter.

With the receiver located about 200 feet from the transmitter, signals of good strength were received with the half-wave receiving antenna coupled to the input of the first radio-frequency stage but none could be heard with the antenna coupled directly to the detector. From other listening tests it was estimated that the gain per stage was of the order of four.

The second receiver was constructed to operate at 75 centimeters or thereabouts. This set was not so elaborate as the one previously described, but more care was taken in placing the tubes so that all

circuit connections would be shorter than before. It consisted of one stage of radio-frequency amplification and a grid-leak detector. As before, the set was enclosed in a small brass box and completely shielded. Figure 15 shows a photograph of this receiver.

Inasmuch as it was desired to obtain as high a value of input and coupling circuit impedances as possible, tuning condensers were eliminated and use was made of the tube interelectrode capacitances only. This made it necessary to fix the tuning of the set. The initial tuning necessary to line up the amplifier and detector circuits at approxi-

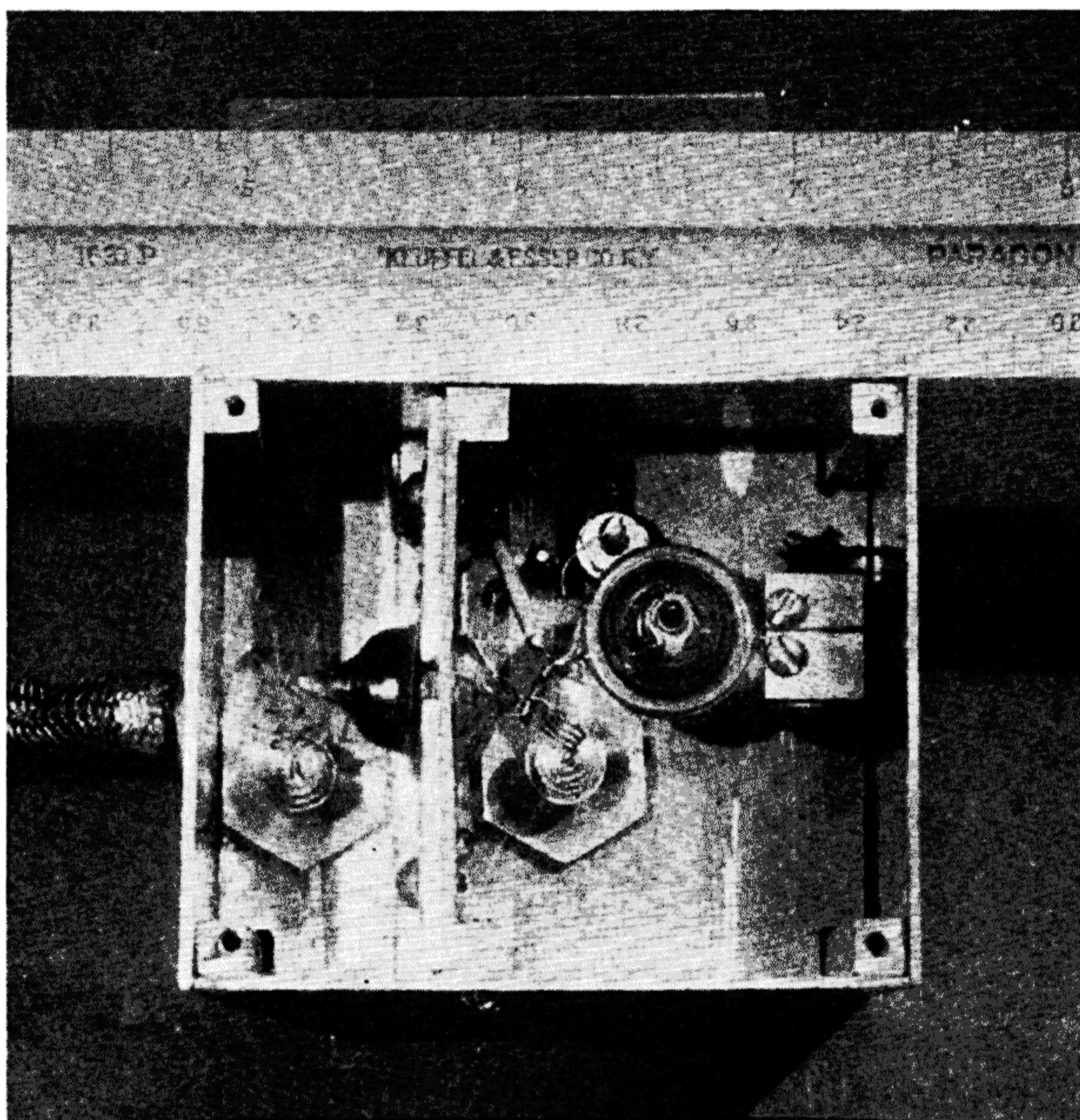

Fig. 15—Photograph of the tuned radio-frequency receiver for a wavelength of 75 centimeters. The scale is marked in inches.

mately 75 centimeters was accomplished by changing the turn spacing of the tuning coils, thereby varying their inductances. The frequency of the transmitter was adjusted by means of a variable condenser to bring it into tune with the receiver.

Following much the same procedure as before, except that the distance from oscillator to receiver was less and the tests were carried out in a large shielded room, the receiver output when the antenna was coupled to the radio-frequency stage was compared to its output when the antenna was coupled directly to the detector. Again these comparisons were qualitative rather than quantitative. While the contribution of the radio-frequency stage was found to be small, it did

furnish some gain as evidenced by the increase in output when it was operating.

CONCLUSION

While no claim is made to optimum design of either tubes or circuits, it has been demonstrated that it is possible to produce tubes of small physical dimensions with characteristics which permit radio-frequency amplifiers, oscillators, and detectors to be used at wavelengths well below one meter in the conventional manner. It may be of interest to consider the significance of these results.

A sensitive, compact, and economical receiver should be only a problem of design in accordance with well-known principles. For example, a superheterodyne circuit might be used, with one stage of radio-frequency amplification to block the local oscillator from the antenna. The intermediate frequency might well be in the range from two to five meters, as these tubes should afford excellent amplification at such wavelengths.

In conclusion the authors wish to point out that the tubes which have been described were made in the laboratory with the object of demonstrating certain fundamental principles, rather than of producing a commercial tube design. However, it is hoped that these principles will be of value in the future development of special short-wave tubes.